

Visibility and Analytics for Cloud Networks

IBM – CogNETive!

Dean H. Lorenz,
Eran Raichstein, Aidan Shribman

Israeli Networking Day
May 2018



IBM's Data and Analytics Reference Architecture

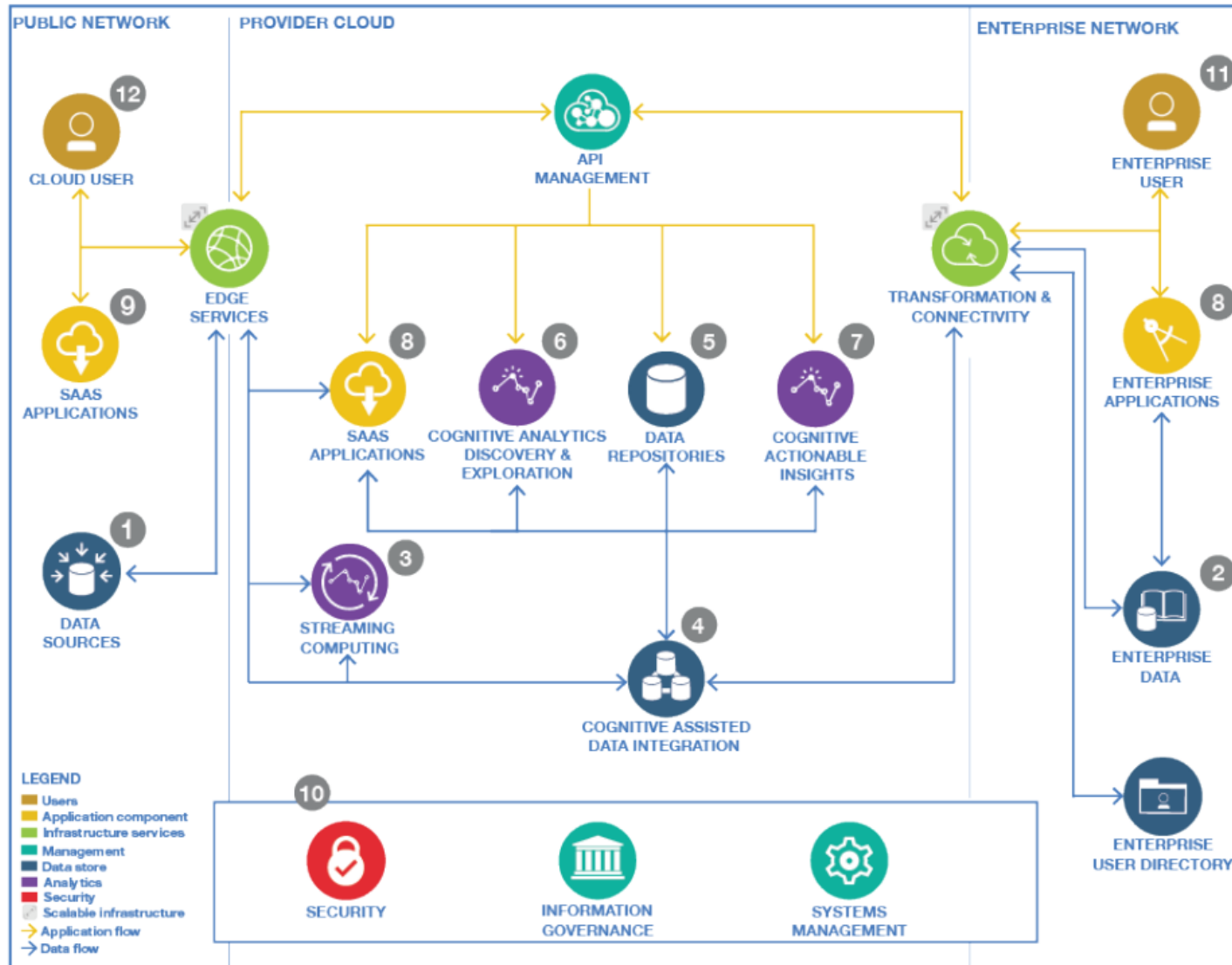

<https://www.ibm.com/cloud/garage/architectures>



I can't see the network...

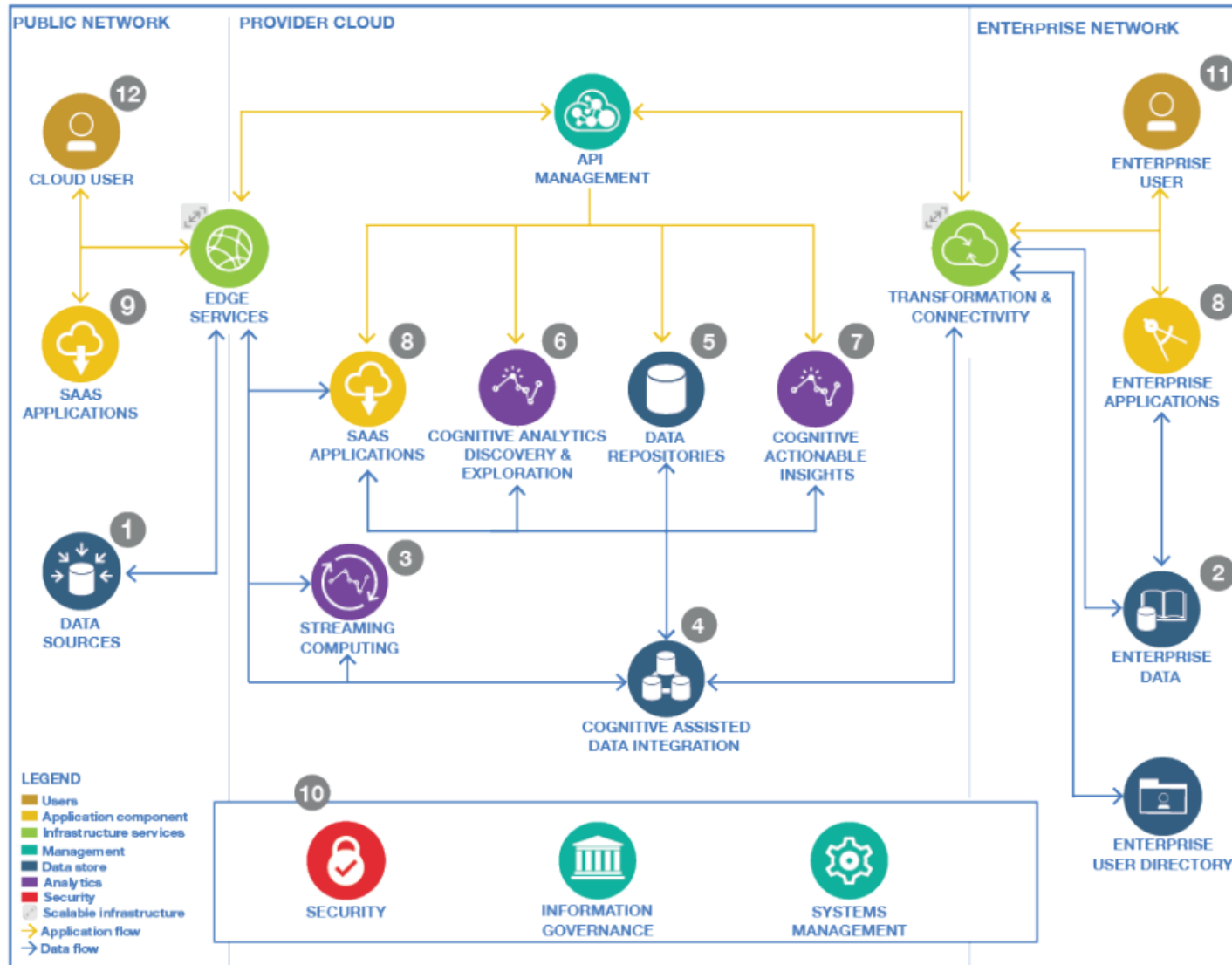

<https://www.ibm.com/cloud/garage/architectures>

Show me the network!

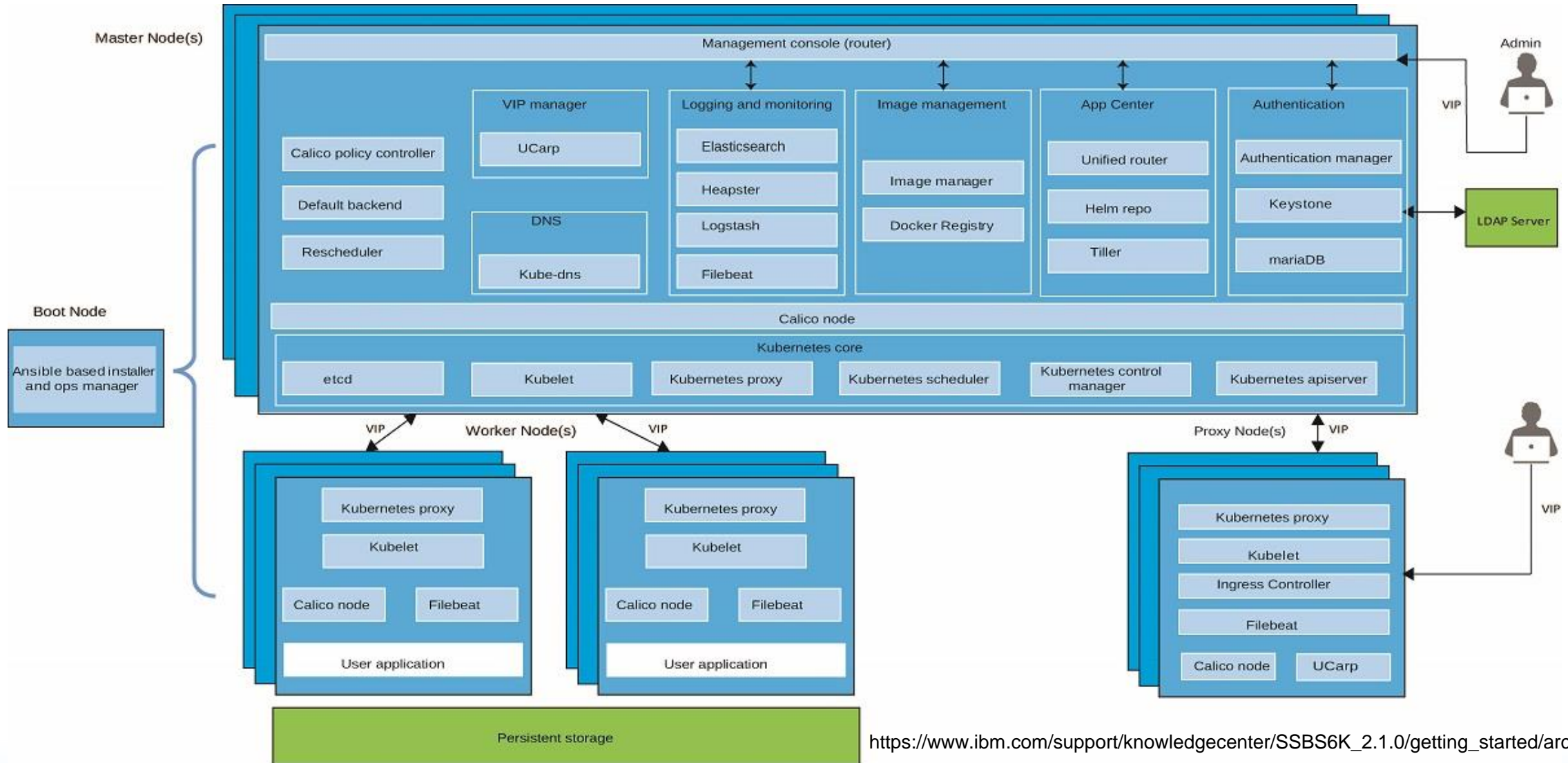

https://www.ibm.com/support/knowledgecenter/SSBS6K_2.1.0/getting_started/architecture.html

The real network...

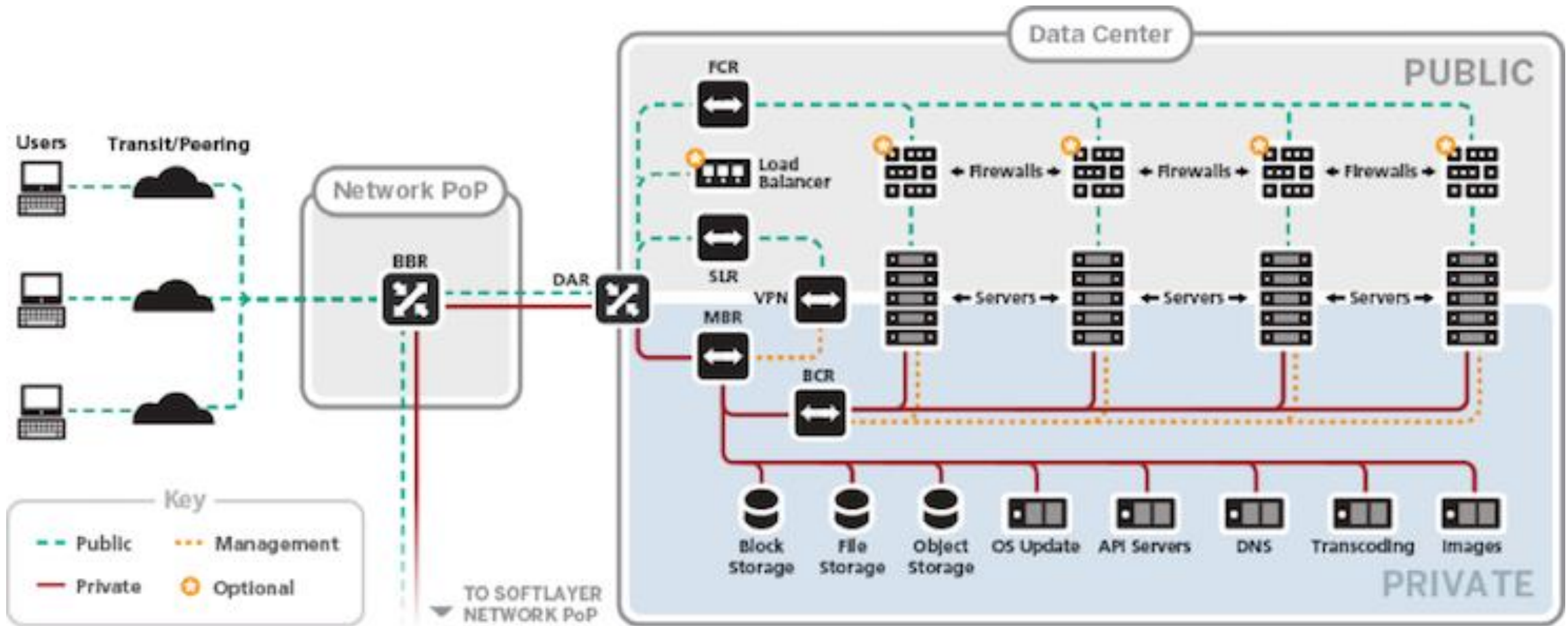

<https://www.ibm.com/blogs/bluemix/2017/05/kubernetes-and-bluemix-container-based-workloads-part1/>



Still can't see enough





There it is...





Target Persona



Help me!

Who are you?

I am an SRE

?

Site Reliability Engineering (SRE)

Apply software engineering to IT operations problems.

“Fundamentally, it’s what happens when you ask a software engineer to design an operations function...

... responsible for availability, latency, performance, efficiency, change management, monitoring, emergency response, and capacity planning.”

source: Ben Treynor/Google VP Eng. (<https://landing.google.com/sre/interview/ben-treynor.html>)

Step 1: Data Capture

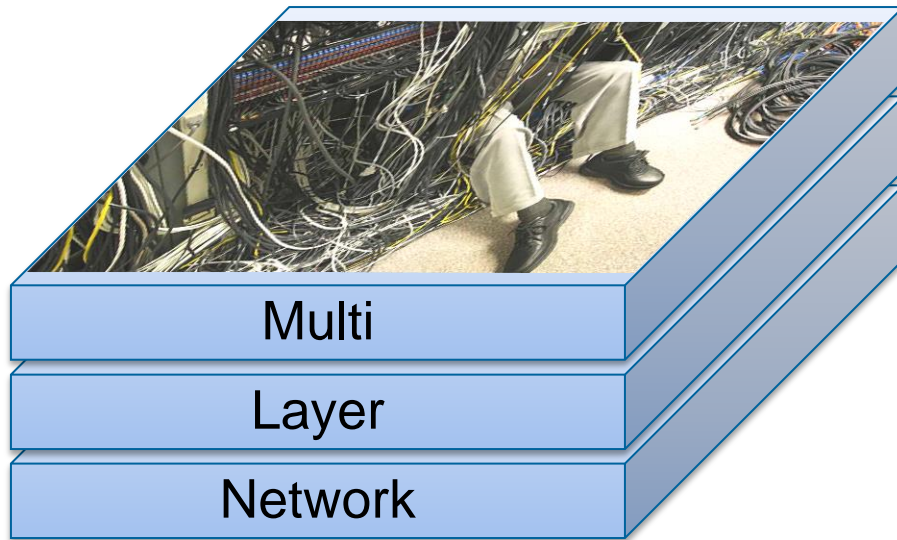

Topology

Telemetry

Traffic



Step 2: Network Exploration

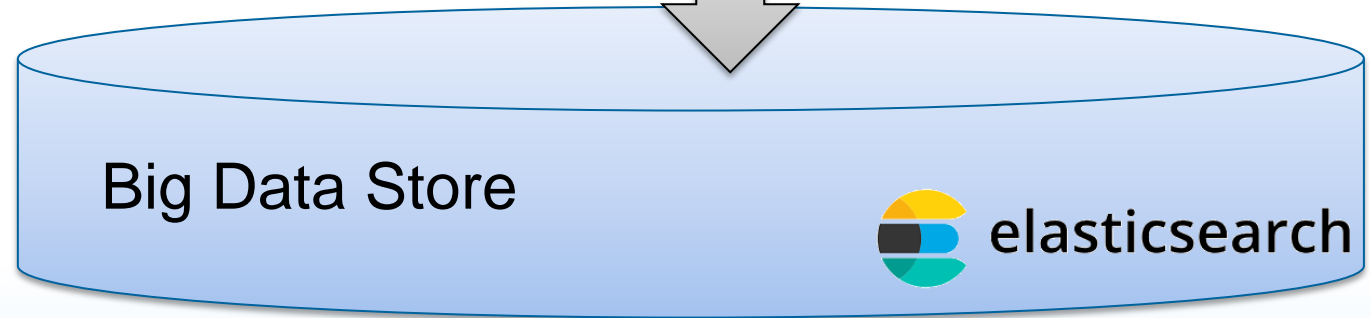
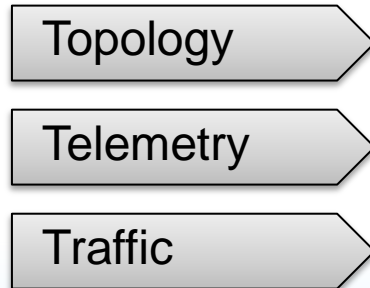
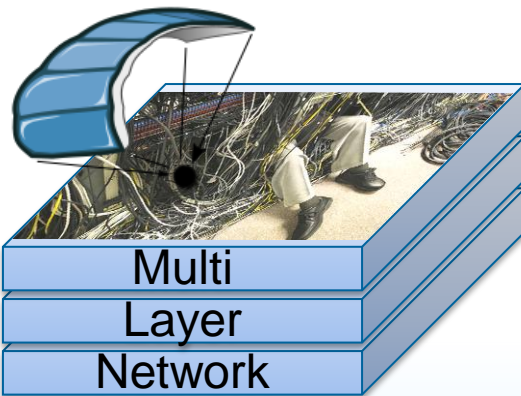
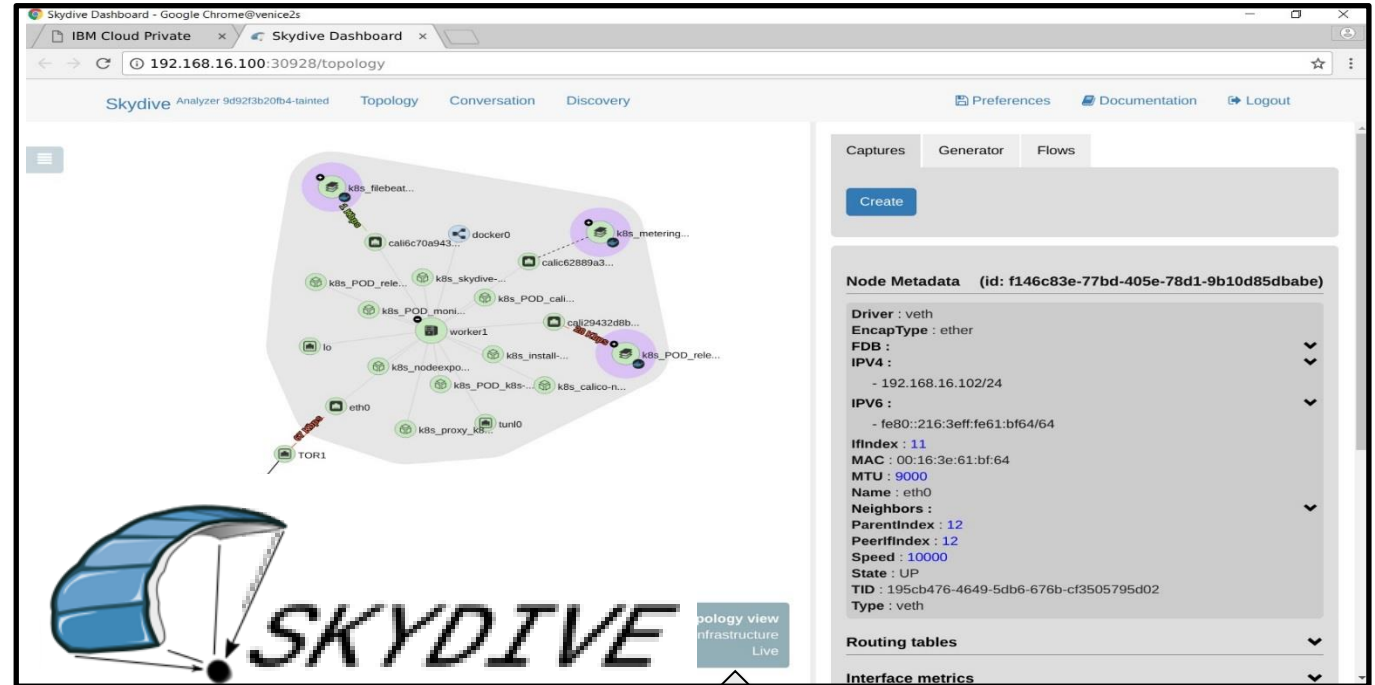

Step 2: Network Exploration



SkyDive
Real-time network analyzer

Skydive is an **open source** real-time network topology and protocols analyzer

<http://skydive.network>

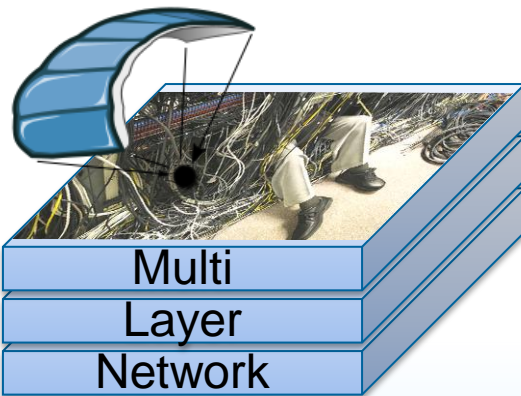
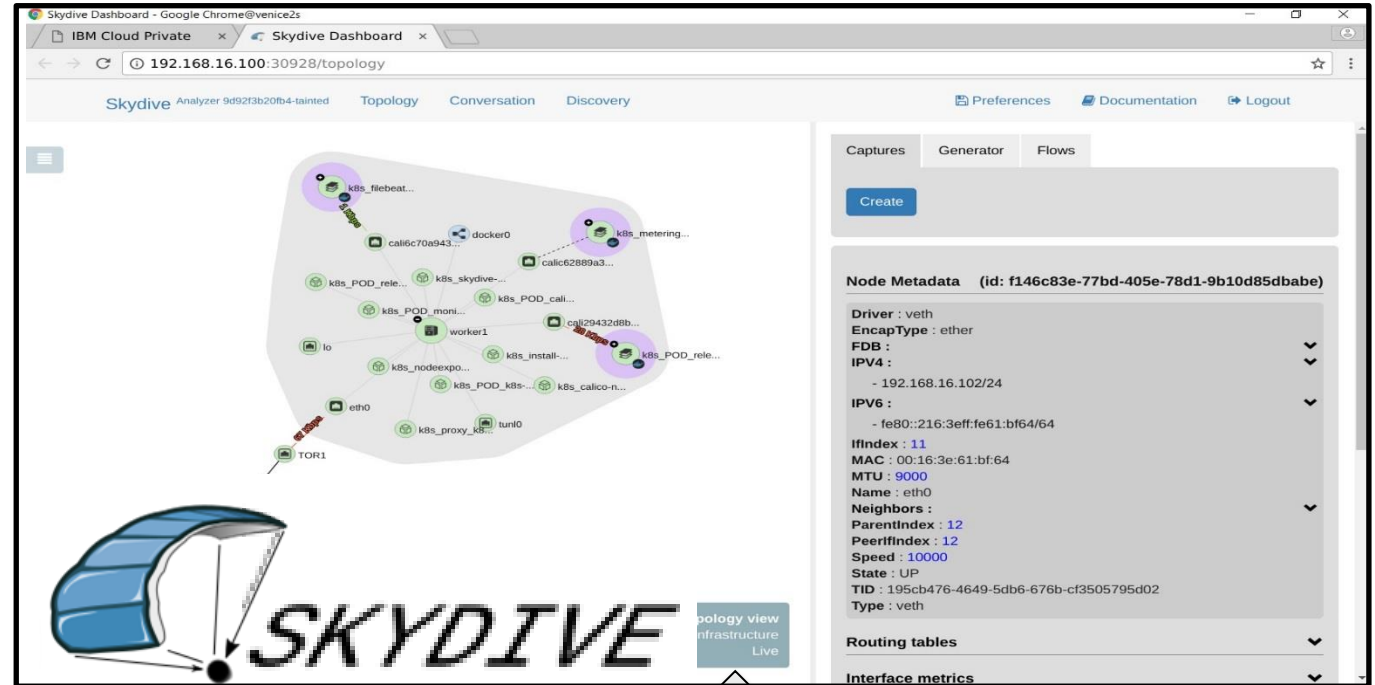

- Topology
- Telemetry
- Traffic

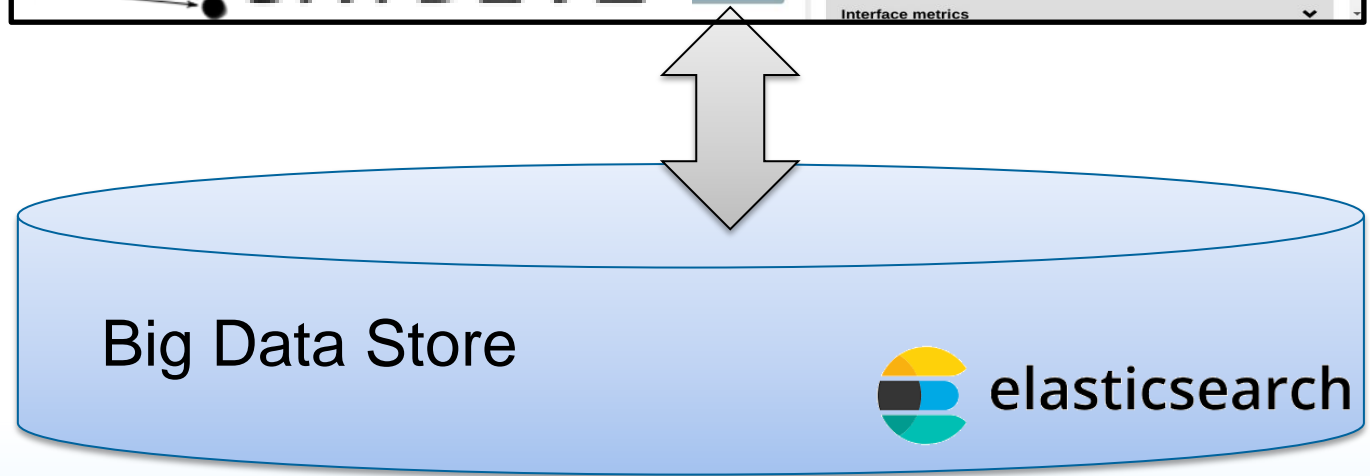

Step 3: Analysis and Insights



IBM CogNETive! An IBM Research project

Augmented Network
Visualization and Troubleshooting
for Operations@Scale

<http://cognetive.sl.haifa.il.ibm.com>

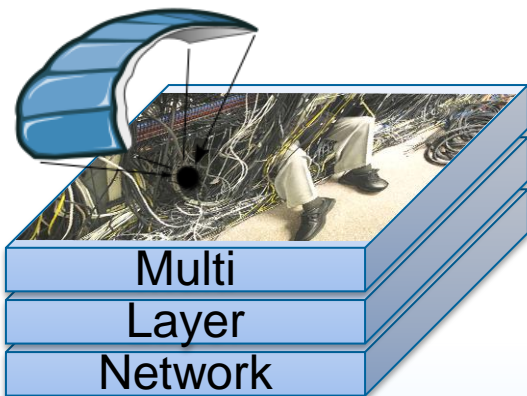
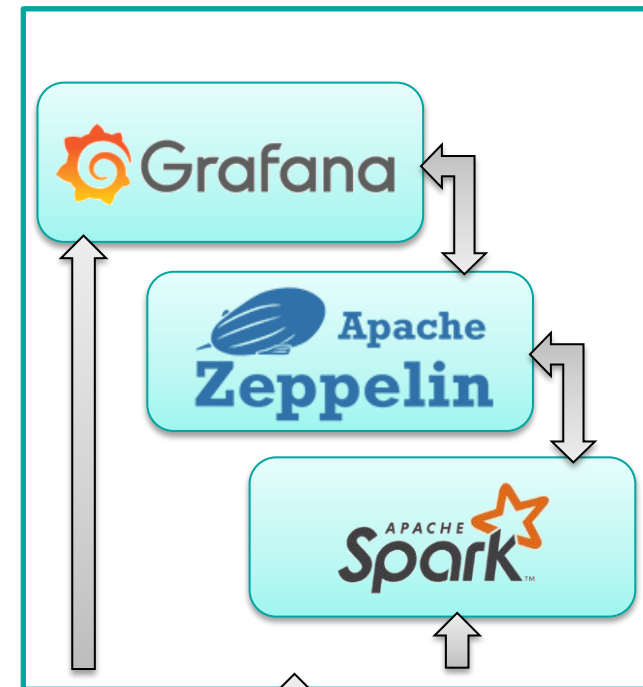
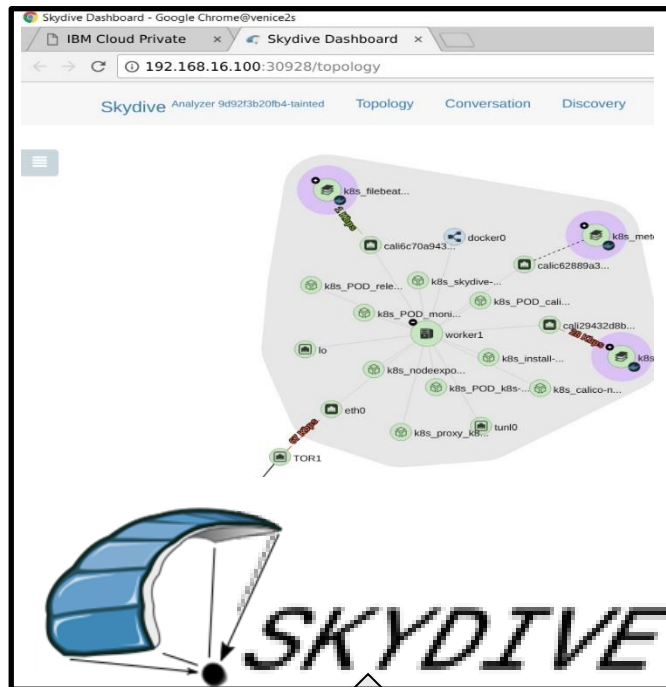

- Topology
- Telemetry
- Traffic

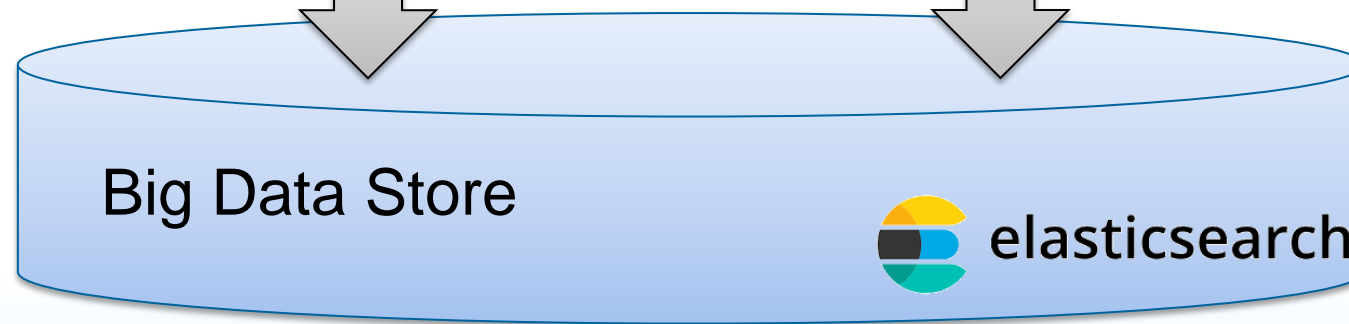



Step 4: Application Awareness

- ❑ Slice through the abstraction layers
 - Identify per-application traffic
 - Measure application metrics
 - Correlate infrastructure insights to app context
- ❑ SliceNet EU H2020 5G Project
 - End-to-End Cognitive Network Slicing and Slice Management Framework in Virtualised Multi-Domain, Multi-Tenant 5G Networks
 - <https://slicenet.eu/>
 - 3 Use Cases
 - eHealth, SmartCity, SmartGrid
 - Verticals in the Loop
 - Integrated application feedback for QoE optimization
 - Collaborative information and insight exchange between different layer owners

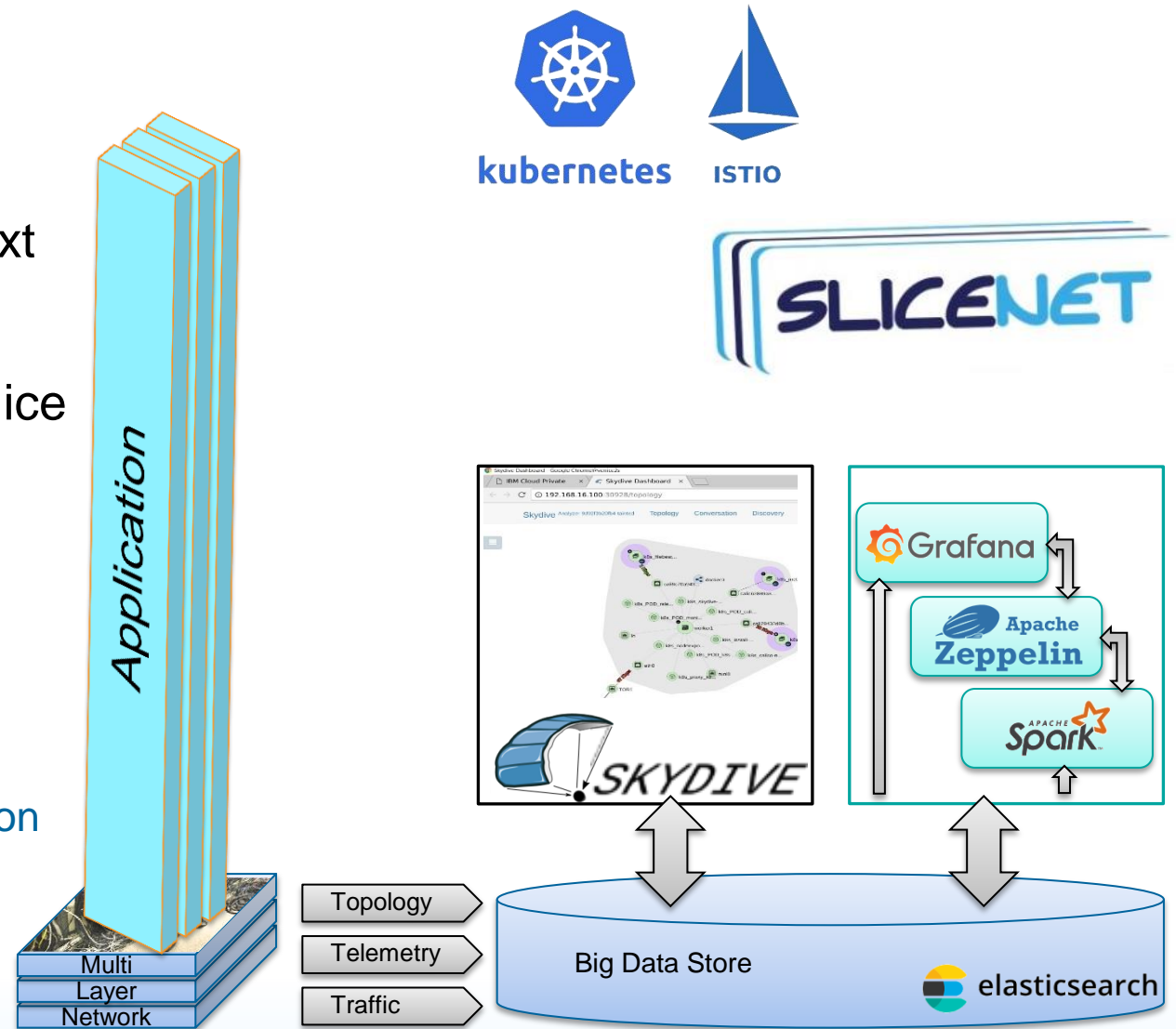

Where We Are

- ❑ We implemented a framework for @scale network analysis
 - SkyDive captures network data – topology, telemetry, traffic
 - SkyDive explores the network and provides multi-layer views
 - CogNETive integrates the analytic tools and enhances some SkyDive features
- ❑ We implemented some analytics
 - Path analysis
 - Anomaly detection
 - SLA validation
 - Security alerts
 - Application behavior

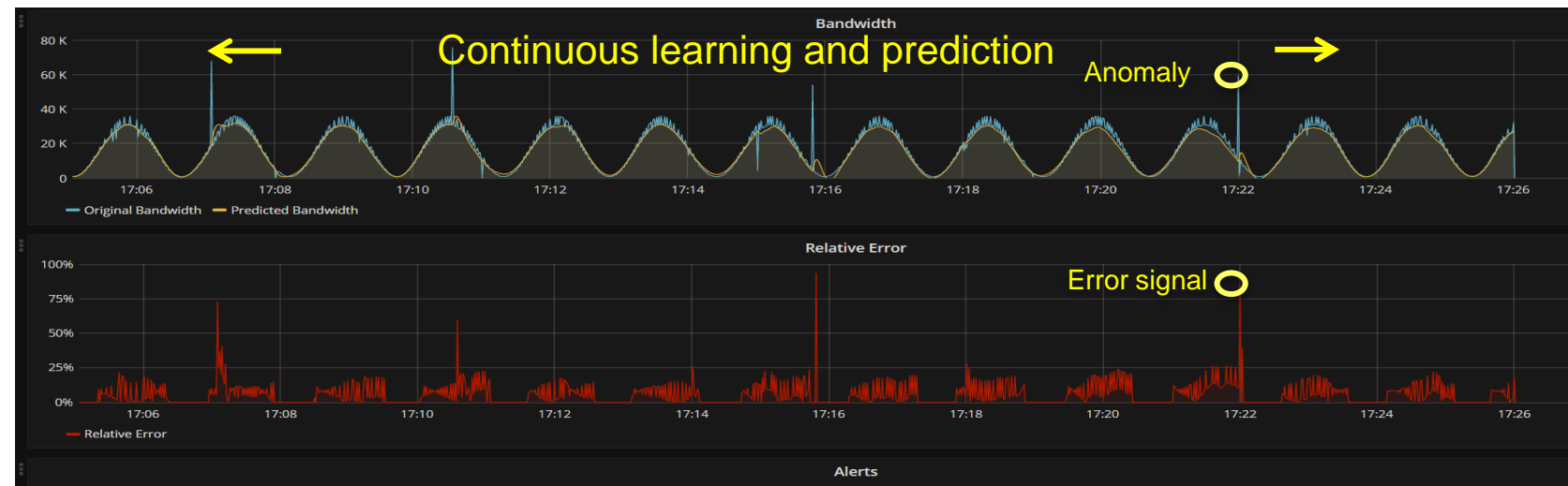

LSTM based bandwidth anomaly detection

Hop-by-Hop Latency

Breakdown of a flow into per-hop latencies

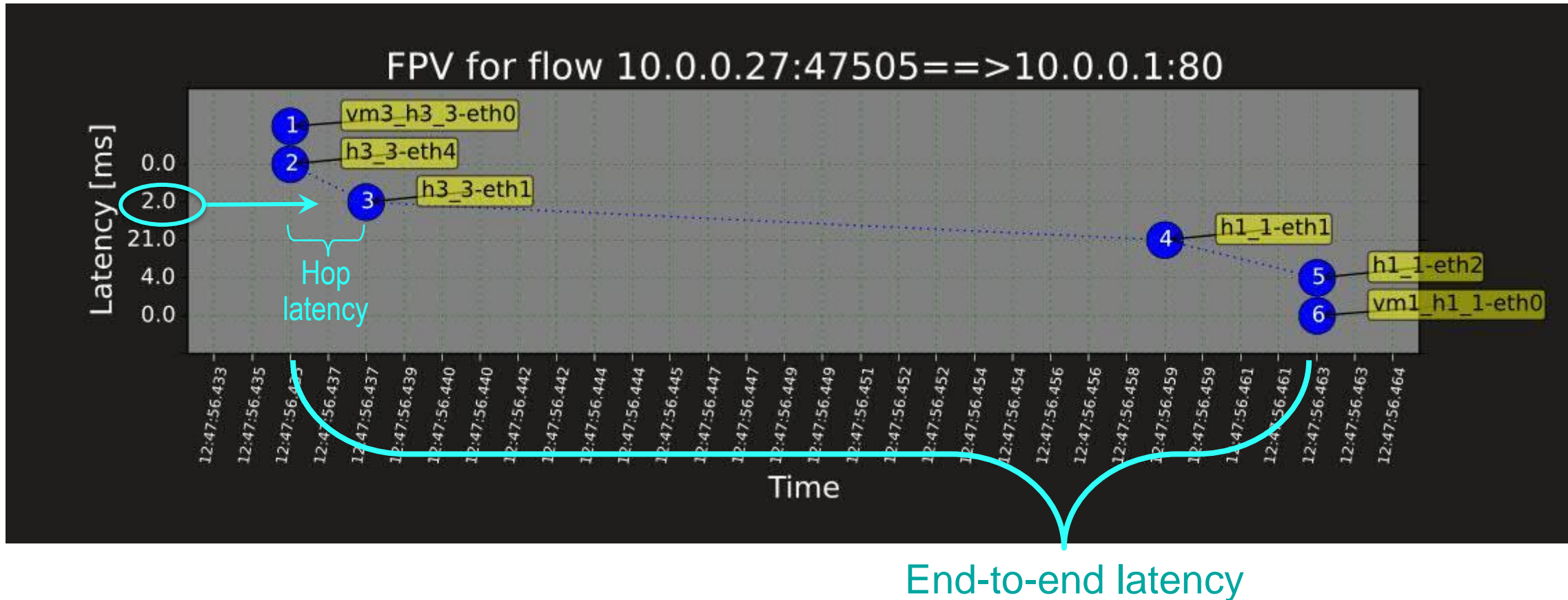



What's Next

□ Call for Collaboration

- Deploy SkyDive on your networks and contribute to the community
- Research
 - Network problems
 - Machine Learning and Cognitive techniques for network analysis
 - Smart probing
 - Multi-layer analytics

□ We are hiring!

- Cloud Architectures and Networking / IBM Research – Haifa
 - Contact: kathy@il.ibm.com
 - Visit us at: https://www.research.ibm.com/haifa/dept/stt/cloud_sys.shtml